

# SteREO Lumar.V12 The New Fluorescence

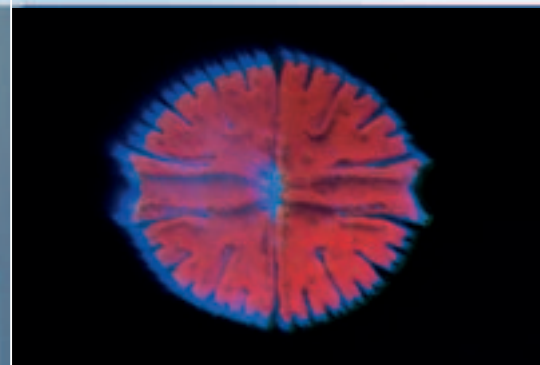

**Brilliant fluorescence  
in stereomicroscopy**



We make it visible.

# Fluorescence

## Carl Zeiss: FluoresScience

**Fluorescence: the basis of many modern microscopic techniques.**

**Fluorescent proteins in particular have become one of the key methods. New fluorescence applications enable increasingly differentiated observation in laser scanning microscopy and light microscopy, where stereomicroscopic fluorescence applications have gained enormous significance.**

Developing such microscopes and imaging systems is a science in itself. At Carl Zeiss we have committed ourselves to this challenge with uncompromising dedication and extensive know-how. After all, when you are working at the boundary to the invisible, you can't make any compromises. To give your best, you need the best tools possible, tools

- **with the highest efficiency**
- **with the most innovative technologies**
- **with the most powerful imaging systems.**

From the very beginning Carl Zeiss has set high standards in light and in confocal laser scanning microscopy – with internationally leading technologies for fluorescence. Our focus on this key technique for the life science research has a name – Carl Zeiss: FluoresScience. This is the Zeiss seal of quality and our pledge that the best fluorescence tools for the life sciences will be made by Carl Zeiss, both today and in the future.

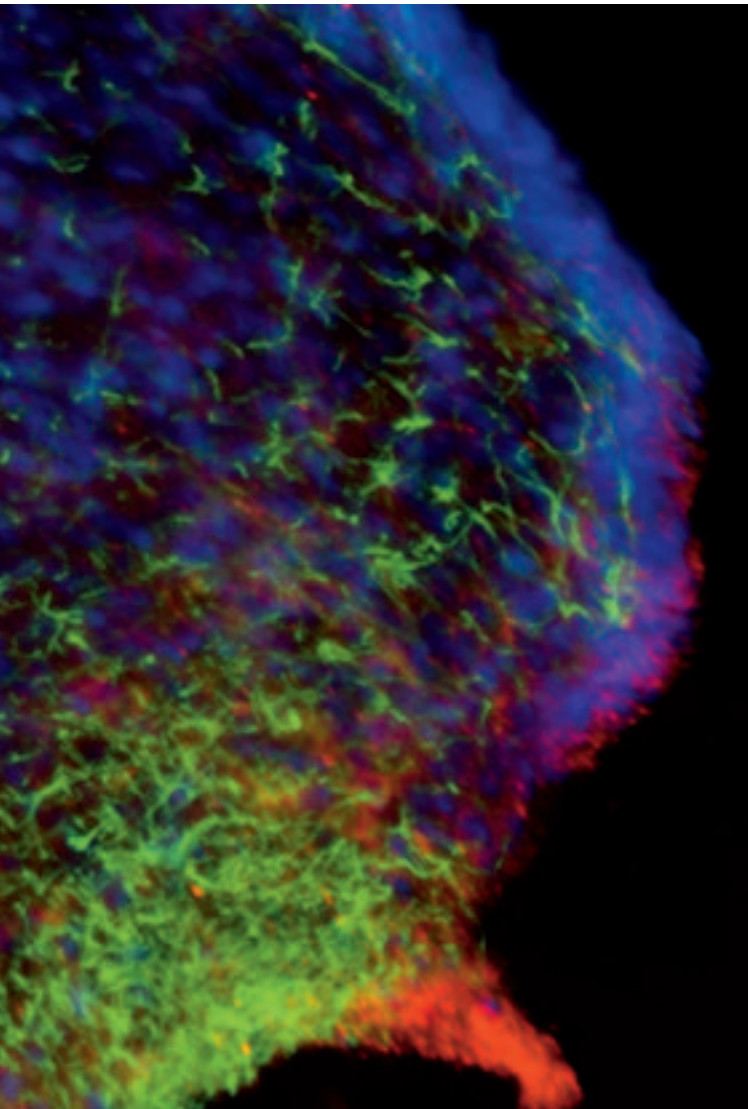

*Tupaia brain.  
Multiple fluorescence  
Objective: NeoLumar S 1.5x  
Magnification 150x\*  
Specimen: Prof. E. Fuchs, S. Bauch,  
Primatenzentrum Göttingen, Germany*

\* Actual viewing magnification.

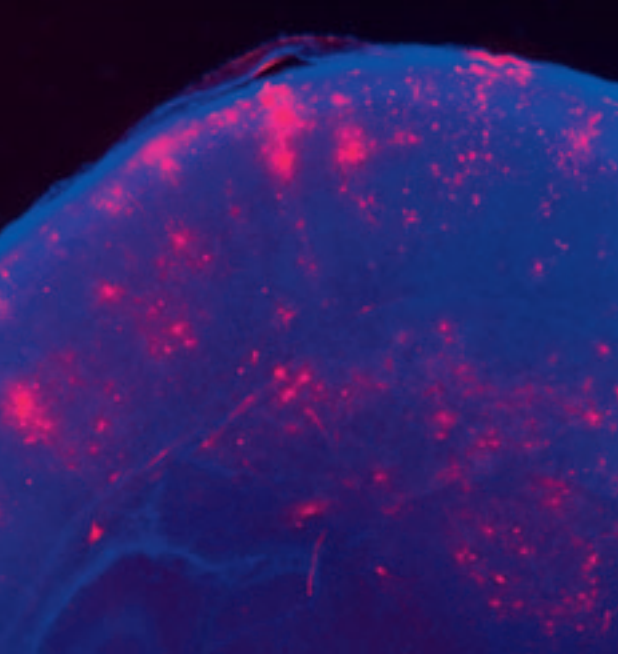

Magnification 23x\*

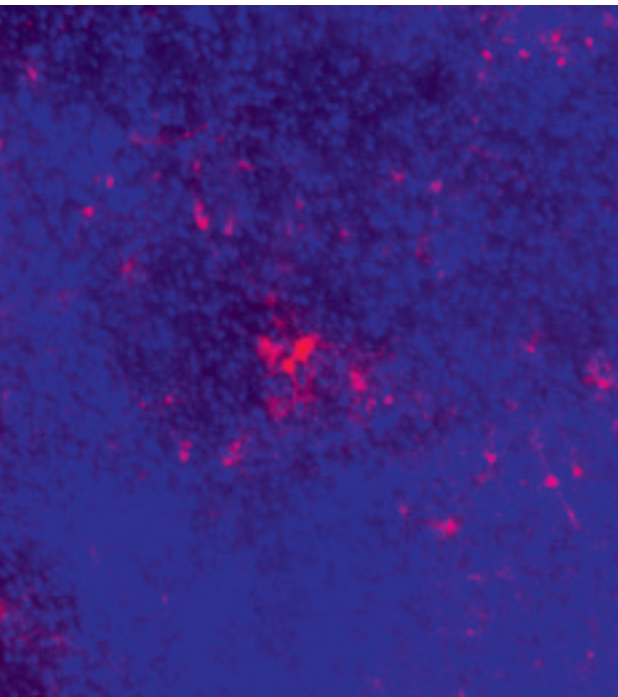

Magnification 80x\*

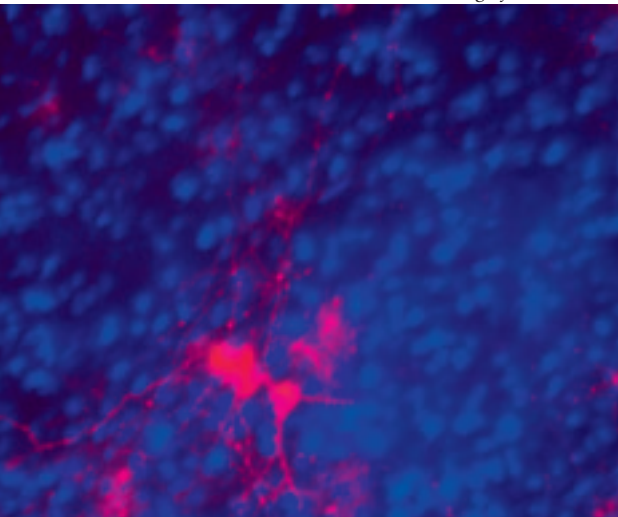

Magnification 150x\*

# Contents

<b>SteREO Lumar.V12 – Expanding the Boundaries</b>	<b>3</b>
<b>Applications</b>	<b>4</b>
<b>Pioneering Work</b>	<b>6</b>
<b>Fluorescence Optics</b>	<b>8</b>
<b>Ergonomics and Operation</b>	<b>10</b>
<b>Operation Concept: SyCoP</b>	<b>12</b>
<b>Illumination and Contrasting Techniques</b>	<b>14</b>
<b>Imaging System</b>	<b>16</b>
<b>Systems Overview</b>	<b>18</b>

*Mouse cortex*

*Dil-labeled single neurons with DAPI  
counterstaining of the cell nuclei*

*Objective: NeoLumar S 1.5x*

*Specimen: Prof. J. Bolz, A. Güllmar*

*Friedrich-Schiller-Universität  
Jena, Germany*



# SteREO Lumar.V12

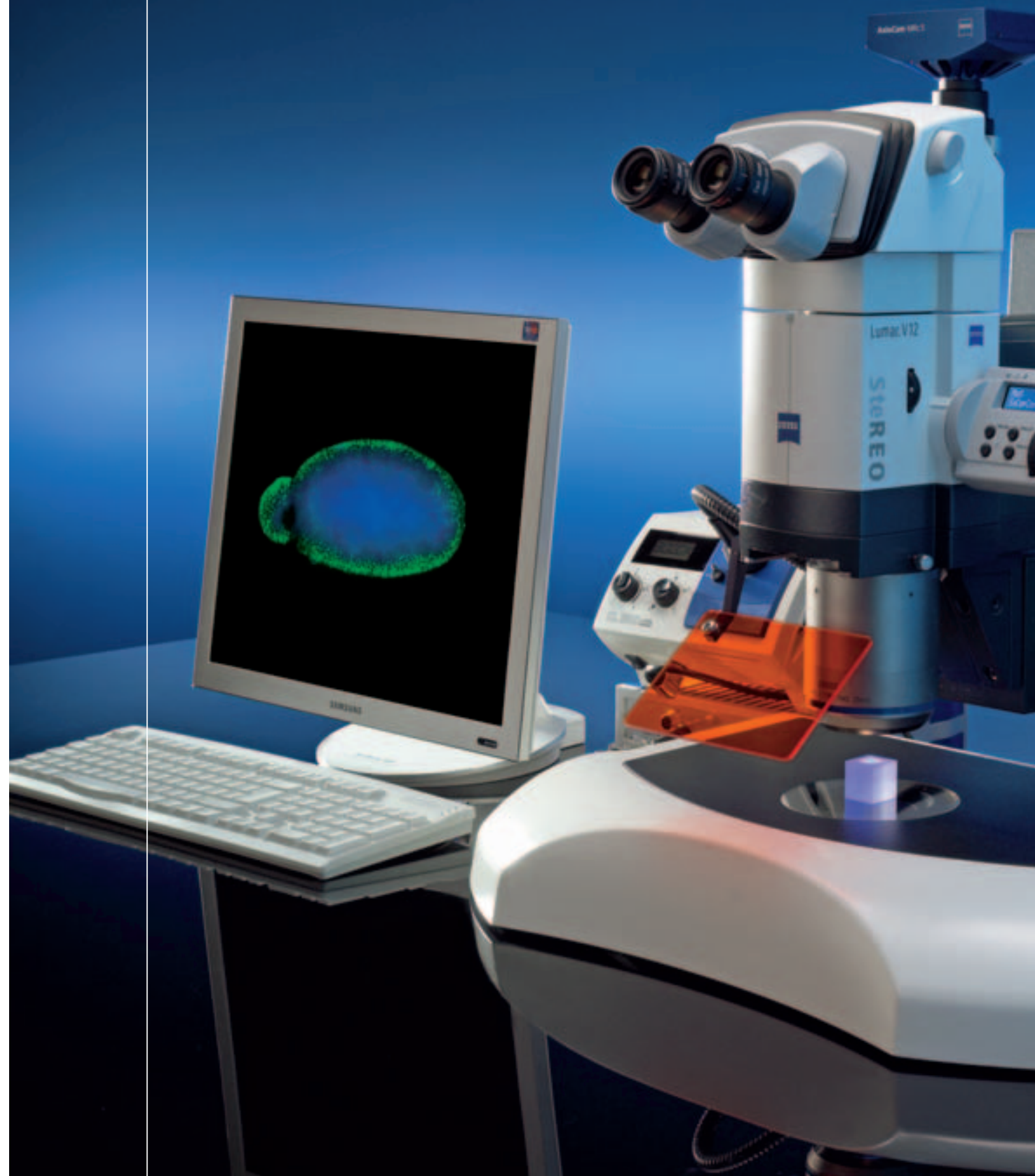



## **Expanding the Boundaries of Stereomicroscopy**

High-resolution three-dimensional images in the largest specimen field in its class. First-class optics through the new objective NeoLumar S for bright fluorescence rich in contrast. Complete motorization and an innovative operating concept. With SteREO Lumar.V12 Carl Zeiss is expanding the boundaries of conventional stereomicroscopy.

# Identifying Much More

SteREO Lumar.V12 has been designed to provide exceptional performance for the diverse applications in stereomicroscopy. In contrast to comparable imaging systems, SteREO Lumar.V12 enables for the first time fluorescence imaging of light microscopy quality. New optics provide the basis for this accomplishment – optics distinguished by the fact that all important components such as zoom attachment, objectives and tubes have been rigorously designed to meet the demands of fluorescence microscopy. Bright fluorescence down into the UV range together with rich contrast are the impressive results of this development.

*Desmid algae Micrasterias,  
chloroplast, nucleus and cell wall  
UV excitation  
Specimen: Dr. M. Zöllfel  
Carl Zeiss*

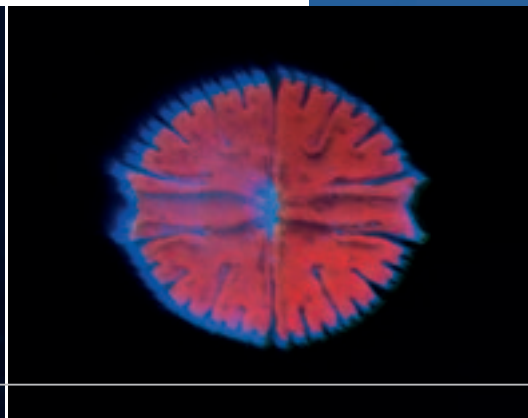
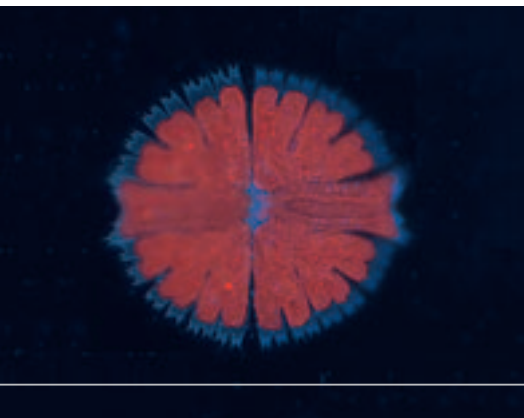

Acquired with light microscope.  
Objective 10x/0.30

Acquired with SteREO Lumar.V12, Objective NeoLumar S 1.5x

*Drosophila embryo.*  
Multiple fluorescence.  
Green fluorescence: cell nuclei, which contain methyliertes Cytosin for transcription regulation, are immune stained with alexa 488.  
Blue fluorescence: auto fluorescence through UV excitation.  
Objective NeoLumar S 1.5x  
Magnification 150x\*  
Specimen: Sameer Phalke  
Universität Halle, Germany

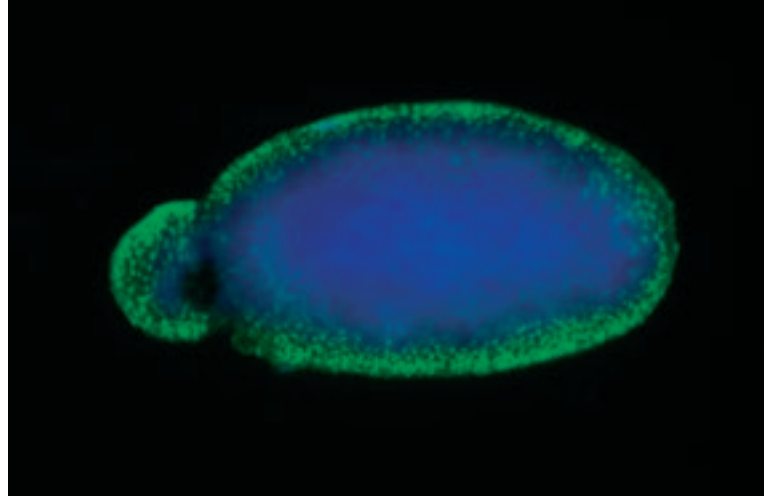

3-day-old Zebra fish.  
Red and green fluorescence: antibody-labeled axon populations and GFP-labeled motoneurons.  
Objective: NeoLumar S 1.5x  
Magnification 150x\*  
Specimen: Prof. M. Bastmeyer, Dr. M. Marx  
Friedrich-Schiller-Universität,  
Jena, Germany

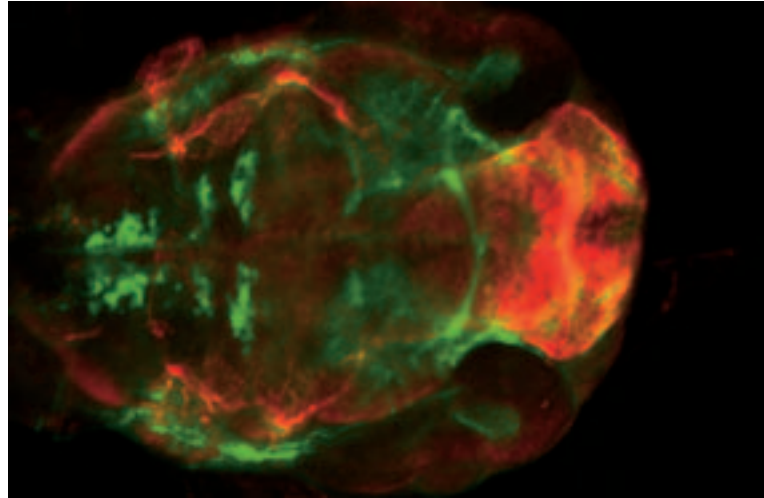

Nerve cells  
tissues culture  
YFP fluorescence.  
Objective: NeoLumar S 1.5x  
Magnification 150x\*

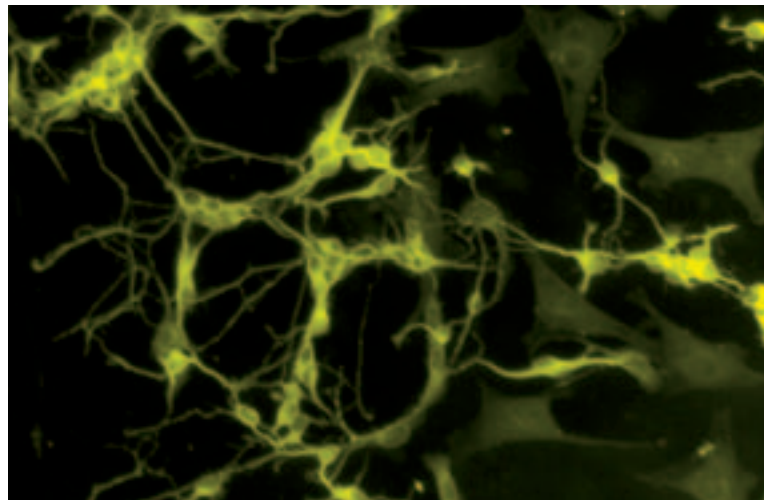

Nematode worm *C. elegans*  
pharyngeal region with GFP-labeled ganglia cells  
Objective: NeoLumar S 1.5x  
Magnification 150x\*  
Specimen: Prof. R. Schnabel,  
Technische Universität, Braunschweig  
Institut für Genetik, Germany

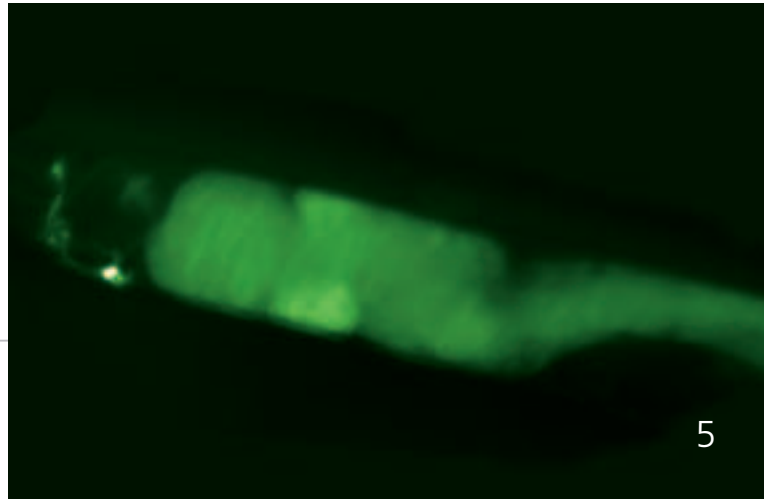



## Pioneering Work from Carl Zeiss

As the heart of a microscope, the objectives determine the optical performance of the entire system – particularly in the case of fluorescence microscopy. Carl Zeiss, a leader in fluorescence microscopy, has invested its entire know-how and experience in the development of new fluorescence objectives for SteREO Lumar.V12. Now you can profit from this know-how: with NeoLumar S, you have two objectives at your disposal both setting new standards in fluorescence applications.

*Microstructured substrate immune  
fluorescent-stained with adherent cells.  
Objective: NeoLumar S 1.5x  
Magnification: 150x\*  
Specimen: Prof. M. Bastmeyer, Dr. D. Lehnert  
Friedrich-Schiller-Universität  
Jena, Germany*

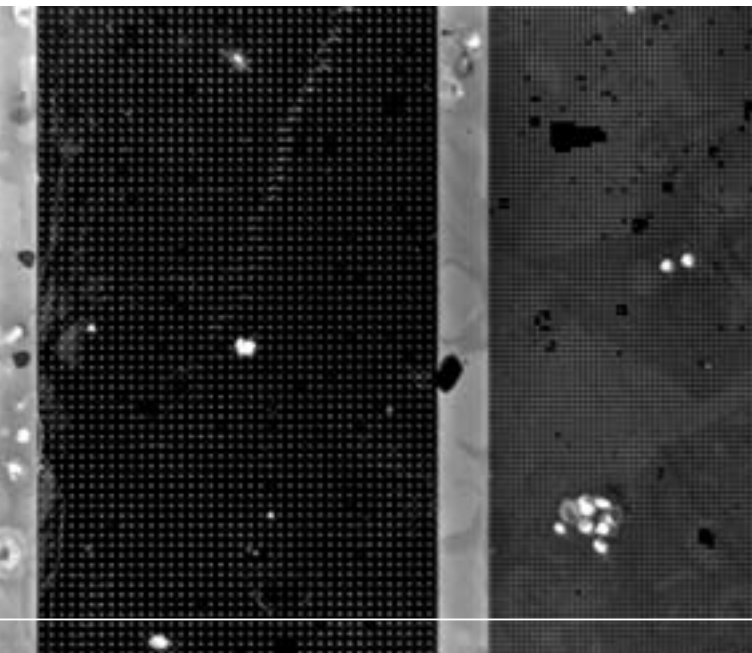

### Fluorescence highlights:

#### Objectives for greater brilliance

The basis for the best fluorescence in stereomicroscopy is provided by two objectives designed especially for SteREO Lumar.V12. With resolution of 0.6  $\mu\text{m}$ , the NeoLumar S 1.5x objective is ideal for overviews and documentation. The NeoLumar S 0.8x objective with its free working distance of 80 mm is particularly suitable for overviews and specimen preparation. You benefit from uncompromising excellence in optics for every application.

### Observing much more:

#### Resolution in large specimen fields

This new optical quality is based on other important components in addition to the objectives – for example, the luminous zoom and the stray-light minimizing tubes for eyepieces with a 23 mm field of view. Together they make the SteREO Lumar.V12 microscope system the new standard in fluorescence stereomicroscopy and give you unrivalled illumination with exceedingly high resolution and exceptional contrast in the largest of specimen fields.

*Clearly resolved for the first time using a stereomicroscope with UV excitation: distances between the single points of 5  $\mu\text{m}$  (left) and 1  $\mu\text{m}$  (right).*



*Fast change of NeoLumar S objective on SteREO Lumar.V12: simply release the lock and slide out the objective.*



*Under absolutely comparable technical conditions and identical specimen position, fluorescence of the SteREO Lumar.V12 stereomicroscope is brighter than the state of the art by a factor of 1.2 to 4x (dependent on excitation wave length).*

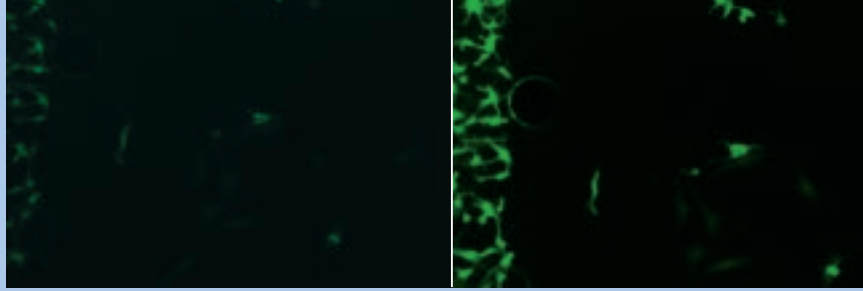

*Nerve cells  
GFP excitation  
Magnification 150x\**

*Specially developed for fluorescence stereomicroscopy: the two objectives NeoLumar S 0.8x and NeoLumar S 1.5x – unrivalled in luminosity and UV transmission.*



*SteREO Lumar.V12 with  
NeoLumar S 1.5x objective*

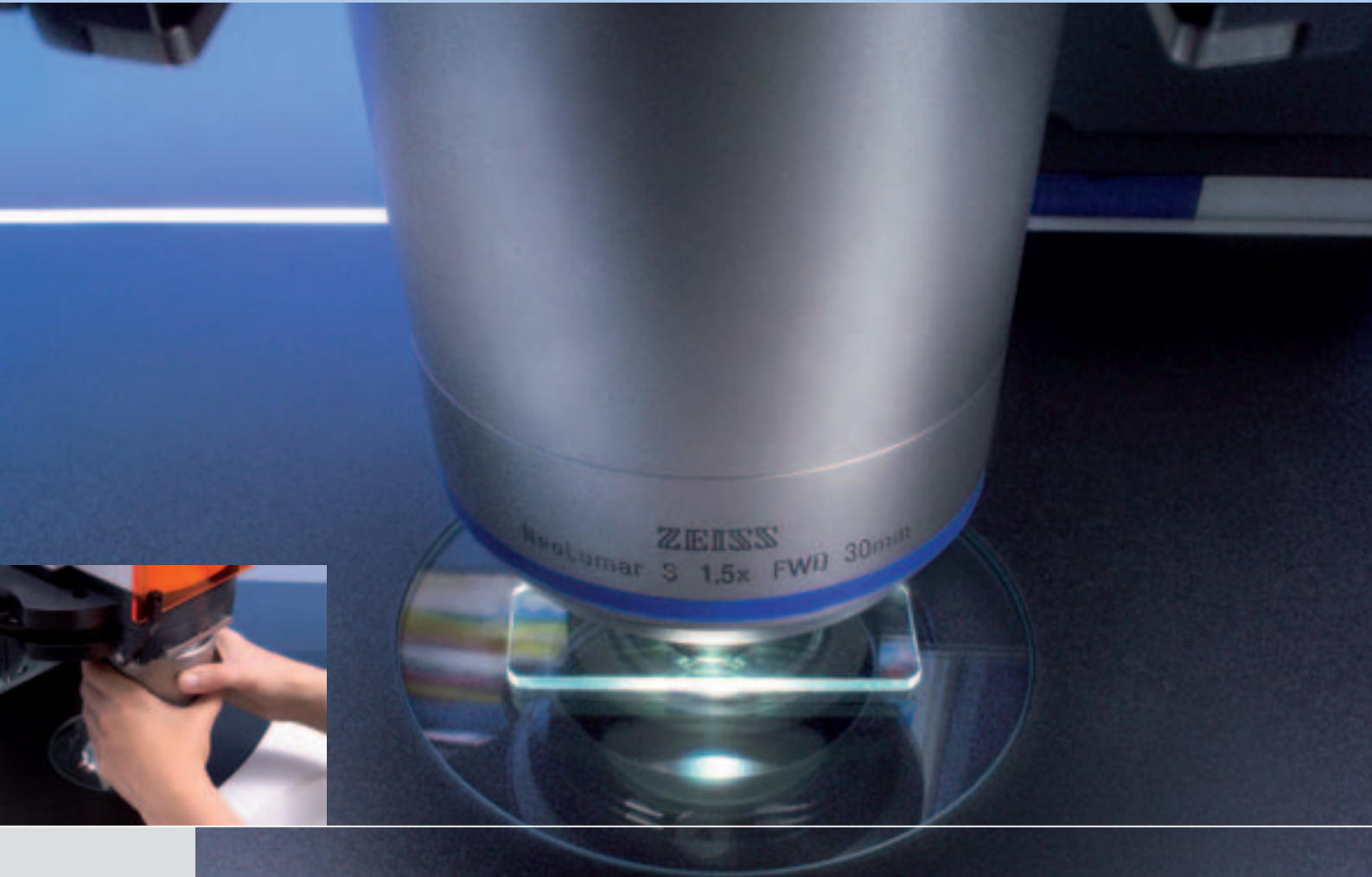

# Shining Examples

Developed for conventional light fluorescence microscopy, SteREO Lumar.V12 offers first-class optical illumination systems. These systems feature even illumination of specimens at all magnifications, and an independent zoom for optimal adaptation of fluorescence excitation light to the specimen field selected. In addition, continuous automation makes the handling of filters particularly easy.

## **New freedom in illumination: Light zoom HiLite**

For optimal fluorescence excitation, the integrated light zoom with lamp mount and 4x filter mount (HiLite) is automatically coupled to the observation zoom. A remarkable option: the light zoom can be detached from the observation zoom. The

advantage of the free light zoom: it is possible to individually increase the brightness of selected specimen structures at low resolutions – thereby mobilizing the last reserves of light. And at high resolutions the light intensity can be reduced, thus ensuring deblurred specimens.

## **Fluorescence filter sets: Found in the filter wheel**

For simplification and acceleration of fluorescence: the filter wheel can accept up to four different fluorescence filter sets. Each set consists of an excitation filter and two emission filters. Fluorescence is easy: the filter wheels are inserted into the microscope and automatically recognized (Push&Slide). Changing of the filter sets is motorized.

**Filter wheels**



**Changing the filter wheel**

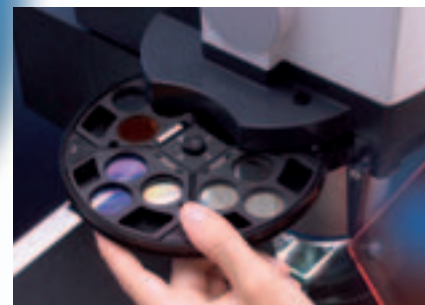

*The filter wheel in SteREO Lumar.V12 offers room for 4 filter sets. Every filter set consists of an excitation filter and 2 emission filters. The filter wheel can be completely removed, enabling you to change filter sets easily. SteREO Lumar.V12 – the powerful fluorescence microscope from Carl Zeiss.*

# Fluorescence system

## **In the picture: AFR for automatic filter recognition**

Effective, error-free work with different filters – a must in modern fluorescence stereomicroscopy. The solution from Carl Zeiss: AFR (Automatic Filter Recognition). SteREO Lumar.V12 recognizes the filter via an integrated color sensor. SyCoP informs you about the available filter sets. In addition, it shows you the filter set currently in the beam path, together with all related spectral data.

*SteREO Lumar.V12 –  
the powerful fluorescence  
microscope from Carl Zeiss.*

**Push&Slide**

**HIP**



*No longer necessary to turn the knob : The HIP (Human Interface Panel) replaces the conventional knob on the stereomicroscope. You can now zoom at any speed you select. Important optical data such as magnification, specimen field diameter, maximum resolution possible or depth of field of the current setting are visible on a display.*



# Stability, Precision and Room for Manipulation

As the optical performance of modern stereomicroscopes grows, so do the technical demands on the mechanics of such systems. The stand and focusing equipment play a major role here. Stability, sturdiness and sufficient room in the specimen field are as important as rapid and reproducible focusing on the specimen – adapted to the individual application.

## Extreme precision: Motorized focusing

Fast and highly sensitive – the newly developed high-quality mechanics of the motor focusing are as accurate as clockwork. Using HIP (Human Interface Panel), the focus can now be rapidly set and precisely reproduced – if desired, via the fine setting in 350 nm steps! This amazing precision can even be attained with equipment weighing upto 17 kg across a 340 mm travel range.

## Intelligent tool: The focus manager

Focusing on a specimen have been enormously simplified: After objective is changed, a corresponding speed profile is automatically set for focusing – sensitive for high-resolution objectives, fast for low resolution. In addition, you can work with fine focus in steps of 350 nm. An electronic specimen protection prevents damage to your specimens.

## New standard: The Z-measurement

With its sturdy stand design and precise motorization of its focus setting, SteREO Lumar.V12 ensures that the position of the microscope to the specimen can be directly displayed. The Z-position is set to zero at the press of a button, the next specimen detail will be focused, and the difference is displayed with precision of +/- 30 µm.

*Ample room in the specimen space: the unusual stand construction with decentralized profile S column.*

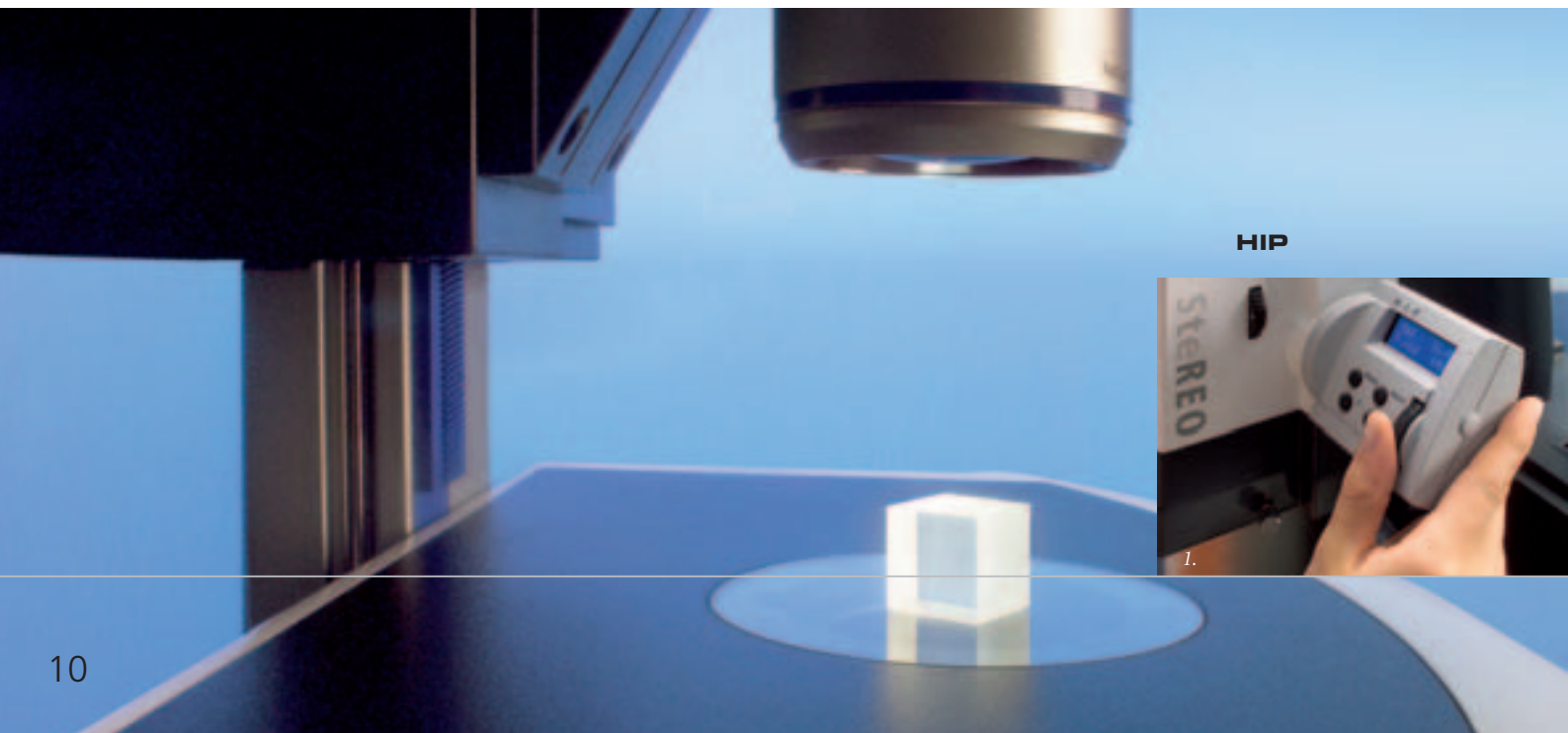

# Stand

*Motorized focusing of the S column – platform for further motorized CANBUS29-controlled components.*

## **Room for objectives: Generous working areas and precise**

Ample room for objects and manipulation: with its large scratch-resistant stage plate (250 x 410 mm), SteREO Lumar.V12 provides you with generous specimen space. Gliding, rotating, ball-and-socket, mechanical and scanning stages can be easily mounted and attached via an interface (120 mm in diameter). The light and highly sensitive adjustable gliding stage is ideal for higher resolutions.

## **Ready for the motorized future: The CANBUS29 system**

SteREO Lumar.V12 was developed as a platform for the motorized and digitalized fluorescence stereomicroscopy of the future. Its open CANBUS29 system "understands" and integrates all motorized components.

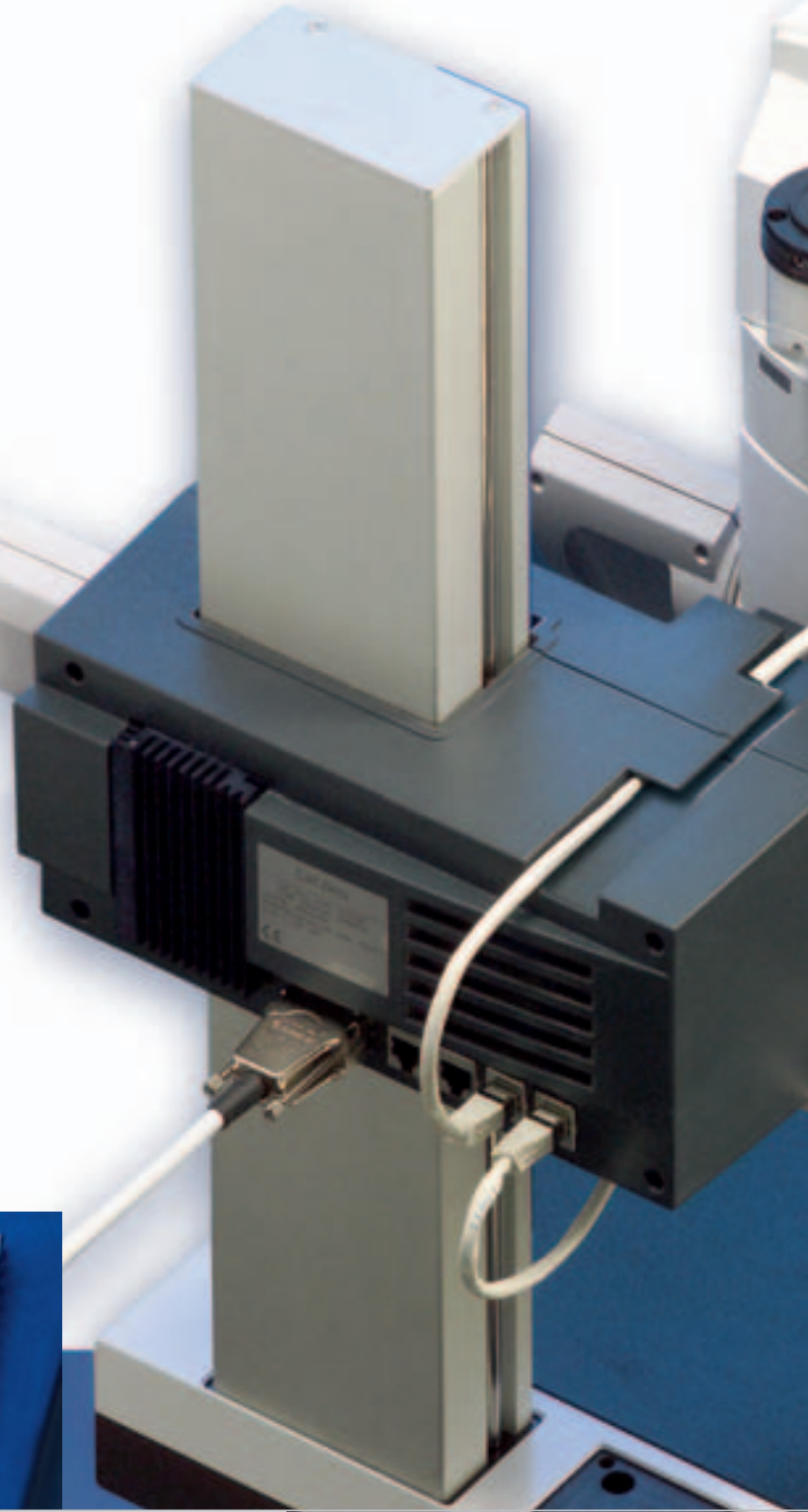

*1. HIP (Human Interface Panel) replaces the conventional focusing knobs with adapted or freely selectable speeds. The current Z-position is always displayed.*

### **Display**



### **Gear rod**

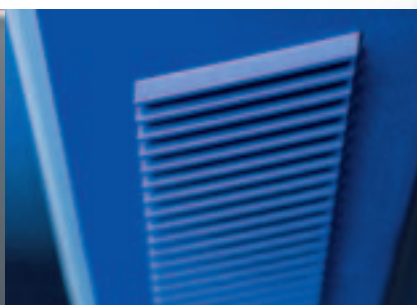

*340 mm precise focusing – new wear-resistant plastics make this possible.*

# SyCoP - A Revolutionary Operating Concept

Specially designed for stereomicroscopy, SyCoP (System Control Panel) combines joystick, buttons and touch screen in the convenient design of a computer mouse, enabling easy handling of increasingly complex operations. With SyCoP you can control all essential functions of a microscope fast, with precision and reproducibly, without lifting your eyes from the eyepiece. This innovative and mobile operating unit makes it possible for you to reach new heights of perfection in automated microscopy. This is particularly important in complicated processes such as fluorescence microscopy, where you should be devoting most of your attention to the specimen – and not to operating your microscope.

## Concentrating on the essentials: SyCoP

Freely positionable, SyCoP can be operated equally well by right-handed or left-handed users. Instead of lifting your eyes countless times to select and control settings, changes and manipulations, you can operate the microscope "by touch" – and keep your eyes and your concentration on the specimen.

## A new feeling in microscopy: Joystick for focus and zoom

Zoom in by joystick in the east-west direction, focus in the north-south – the two most common processes in microscopy can now easily be controlled via one operating element, saving you time and unnecessary movement. In addition, you can control light or quickly switch on illumination and contrasting techniques via fixed buttons. The touch screen has two functions: as a display for data and information and as a further control panel to "switch on" additional functions of the stereomicroscope.

## More automation: Future options with SyCoP

SyCoP is also an option for the future. Its open concept allows new functions and upgrades all motorized accessories to be added in the future.

Touchscreen



Keys



JoyStick





## **Perfect information: Supplying facts to the microscope**

A further innovation in microscopy: SyCoP informs its users at a glance about all important optical parameters of the current setting, such as total magnification, visible specimen field, maximum resolution possible, and depth of field. For the first

time this information – normally difficult for the user of a stereomicroscope to access – can now be read. Another improvement: the brightness of the display can be adjusted, even turned off, making it equally suitable for work in lighted and darkened rooms.



*Now complex stereomicroscopic systems can be easily operated using only one hand. Reliably and error-free – and without taking your eyes off the specimen.*



## Intelligent Light Management

For the first time in stereomicroscopy there is a self-aligning HBO fluorescence illumination. This unique illumination guarantees consistently reproducible results, avoiding the necessity of time-consuming adjustments. The intelligent integration of fiber-optic illumination components for reflected and transmitted light guarantees the highest possible contrast and optimal illumination, from the overview down to the last detail.

### Self-aligning: The HBO lamp

Prerequisite for strong signals in fluorescence: the new HBO lamp in SteREO Lumar.V12, exclusive from Carl Zeiss. Thanks to the new self-adjusting construction, the HBO burner aligns itself automatically every time it is switched on. This results in a stable, optimum setting during the entire life of the lamp, ensuring perfect illumination of the field of view and consistently excellent fluorescence results.

*Imaging in oblique transmitted-light brightfield for counter-contrasting of transparent and fluorescent specimens.*

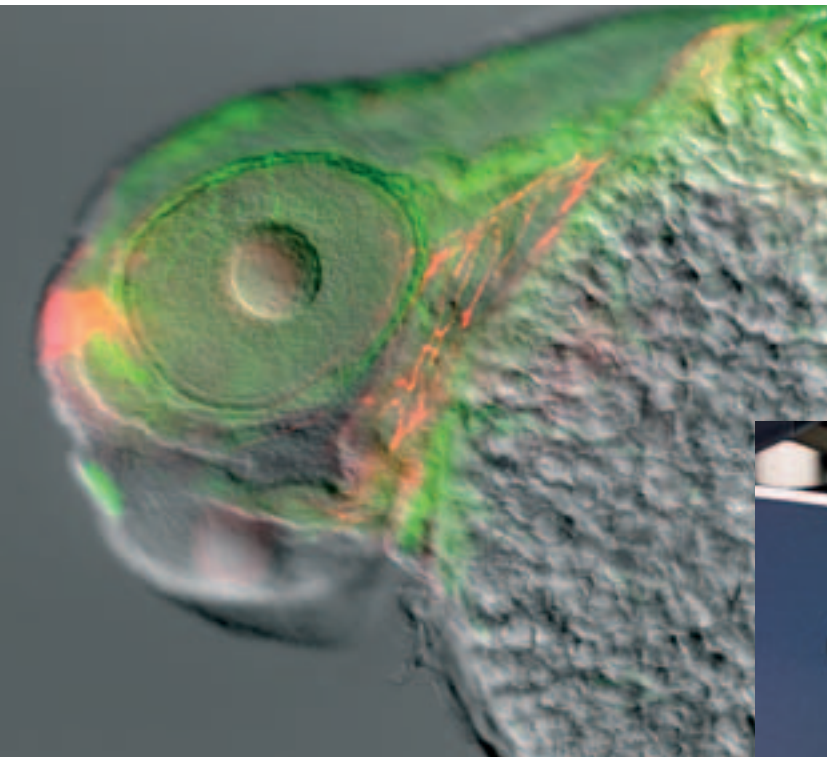

*3-day-old Zebra fish  
Red fluorescence: motor cerebral nerves  
Green fluorescence: motor and sensory cerebral nerves  
Objective: NeoLumar S 1.5x  
Magnification: 150x\*  
Specimen: Prof. M. Bastmeyer, Dr. M. Marx,  
Friedrich-Schiller-Universität  
Jena, Germany.*

**Reflected light**



**Transmitted light**

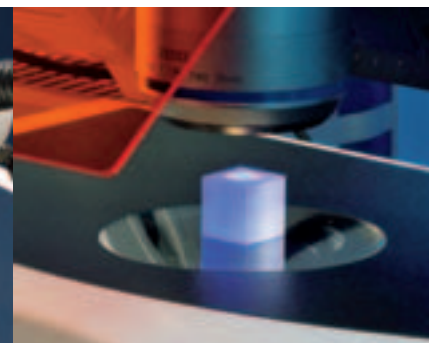

A wide range of fiber-optic illumination components for reflected light can be easily attached to preset interfaces on the microscope.

Ample room for specimens thanks to the generous scratch-free stage plate (250 x 410 mm).

# Contrasting techniques

The HiLite excitation beam path zoom can be detached from the observation zoom and controlled separately. Advantage: reduced intensity of the excitation light during the observation of intensely lit specimens at high magnifications. Unique: the illumination of the specimen field remains homogeneous.

## Practice-oriented alternatives: Powerful cold-light illumination sources

Two powerful cold-light sources provide a valuable alternative to illumination and contrasting equipment for reflected and transmitted light: Schott KL 1500 LCD and Schott KL 2500 LCD. The latter has the higher performance and can be controlled via SyCoP, with its easy-to-find buttons for selecting and regulating light. The Light Manager guarantees that specimens are evenly lit throughout the zoom range while a memory control ensures that user settings are stored and reproducible.

## A good contrast: Transmitted light equipment S

This modular, retrofittable equipment is ideal for brightfield, oblique illumination and darkfield. With its additional flexibility to move the mirror, it offers improved oblique illumination, even at high magnifications. As a result, the images contain more information. The exceptionally large working area simplifies the screening of petri dishes and other culture vessels.

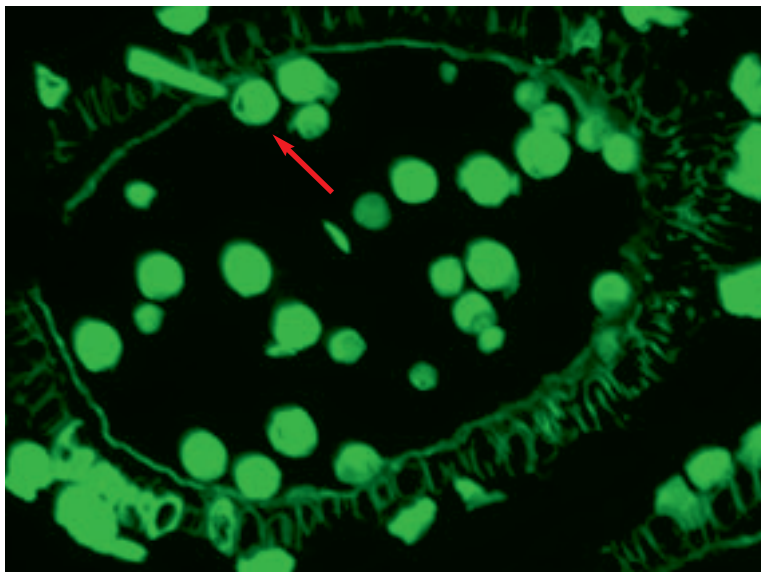

HiLite attached to the observation zoom results in stray light.

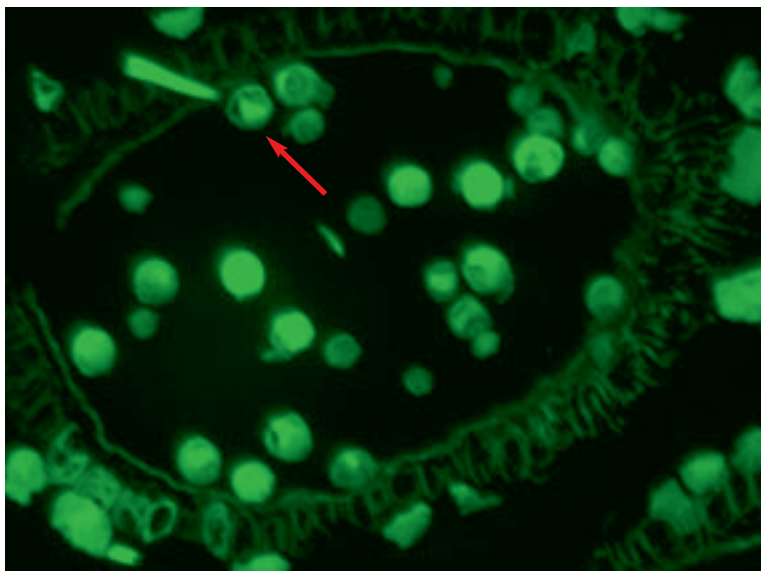

HiLite detached from the observation zoom removed stray light from intensely lit up parts of the specimen.

Hazelnut tree *Corylus avellana*  
Pollen seeds with cell nucleus  
8  $\mu\text{m}$  section  
blue excitation  
Objective: NeoLumar S 1.5x.  
Magnification: 150x\*

## Contrasting

## Lamp



Optimal contrasting in the transmitted light:  
Reproducible attitude of the mirror position  
over a slider.



# From Stereomicroscope to System: Fluorescence Imaging

The system concept of stereomicroscopy is brought to perfection by AxioVision, the software for digital microscope systems. In addition to a unique modular structure that fulfills the demands of current microscopy, it features attractive options for expansion and upgrades. AxioVision integrates microscope control, image acquisition, image processing as well as image analysis, management and archiving into a single system. There is a precise software solution for every requirement which can be easily and inexpensively expanded – from powerful entry models for newcomers right up to systems for advanced users.

## Powerful from the start:

### The basic program from AxioVision

The entry-level version of AxioVision provides you with a high-performance tool featuring an impressive wealth of functions. The benefits for you: software control of your instrument, easy storage of microscope parameters, automatic recall of scaling factors, and easy configuration of individual steps.

## Team work: AxioVision and digital camera systems

AxioVision has interfaces for standard technologies which enable the use of a wide range of cameras – from simple consumer models to scientific ones. Digital cameras from the Carl Zeiss camera family offer additional advantages.

## The AxioCam family: Flexible specialists for every need

The AxioCAM family: Flexible specialists for every need

Carl Zeiss offers a wide range of digital cameras in various performance class. With their high dynamics of 12 or 14 bits, the monochrome cameras feature optimal resolution and high sensitivity, particularly with weak fluorescence specimens. The color cameras provide excellent color reproduction and outstanding resolution – in addition to up to 12 megapixels per color channel without any loss through color interpolation. The cameras are Peltier-cooled and protect specimens through fast shutter synchronization. A particular highlight is the fast live image, even with long exposure times.

3 Tage alter Zebrafisch  
Rot-Fluoreszenz: Motoneurone und ihre  
Efferenzen  
Grün-Fluoreszenz: Axone im Rückenmark  
und schräge Beleuchtung im Durchlicht-  
Hellfeld  
Objektiv NeoLumar S 1,5x  
Vergrößerung 150x\*

Präparat: Prof. M. Bastmeyer, Dr. M. Marx  
Friedrich-Schiller-Universität Jena  
Deutschland

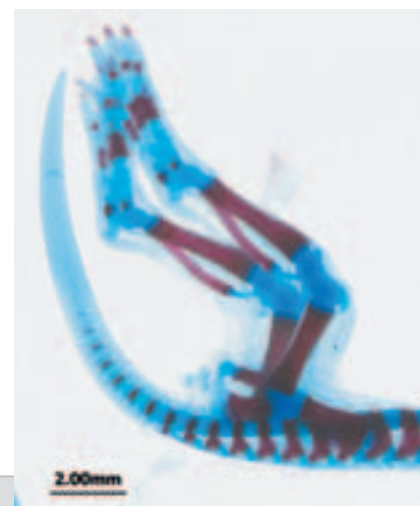
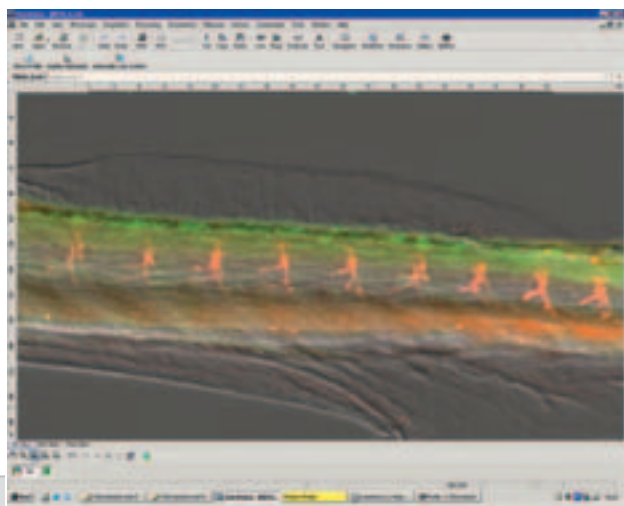

**Fig. 1**  
 Worm *C. elegans* on an Agar plate. Oblique illumination in transmitted light-brightfield  
 Objective: Neolumar S 1.5x  
 Magnification: 150x\*



**Fig. 2**  
 Desmid algae *Closterium* (*Desmidiaceae*)  
 UV excitation  
 Objective: Neolumar S 1.5x  
 Magnification: 150x\*  
 Specimen: T. Friedl,  
 Sammlung von Algenkulturen,  
 Universität Göttingen, Germany

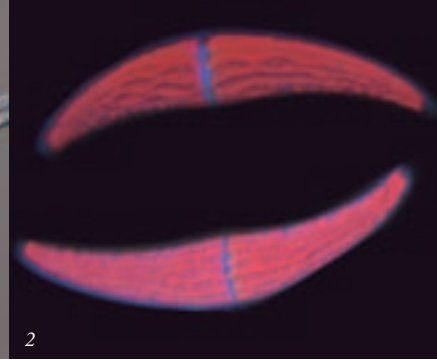

**Visible quality: Functions for image acquisition**

No single work station is like the other. In addition, your requirements change with the growing and diverse demands of your work. With its wealth of image acquisition functions, AxioVision can easily meet these challenges, enabling you to put together exactly what you need for best results. Even simple two-dimensional imaging benefits from the automatically assigned image formats and setting information that are stored together with the image. These reproducible conditions are essential for correct image comparison.

**Life in focus: Modules for the observation of living organisms**

Oriented towards the requirements of biomedical laboratories, powerful and easy to operate: AxioVision has acquisition modules for multichannel and time-lapse fluorescence images. With a mechanical or electronic specimen stage, easily assembled images can also be created with the new modules MosaiX and Panorma. You get outstanding resolution while maintaining image overview.

**Measurement, documentation, archiving: AxioVSION for the analysis and management of images**

For individual or routine measurements of your specimens: AxioVision provides you with the tools you need to analyze image information - whether interactively or automatically. Modules to archive image, text and graphic, simplify information and accelerate data management. You can catalogue images, assign categories and keywords and add annotations and comments. Meta data from the images are automatically taken over, displayed, exported and processed.

*Skeletal preparation of a newborn mouse*  
 Red staining: calcified bone tissue  
 Blue staining: cartilage tissues  
 Transmitted-light, brightfield  
 SteREO Discovery.V12, Objective PlanApo S 0,63x  
 AxioCam MRc5, AxioVision (Module Panorama)  
 Magnification 5x\*  
 Sample: Dr. Kenji Imai, M.D., PhD.  
 GSF-National Research Center for Environment and Health  
 Neuherberg, Germany

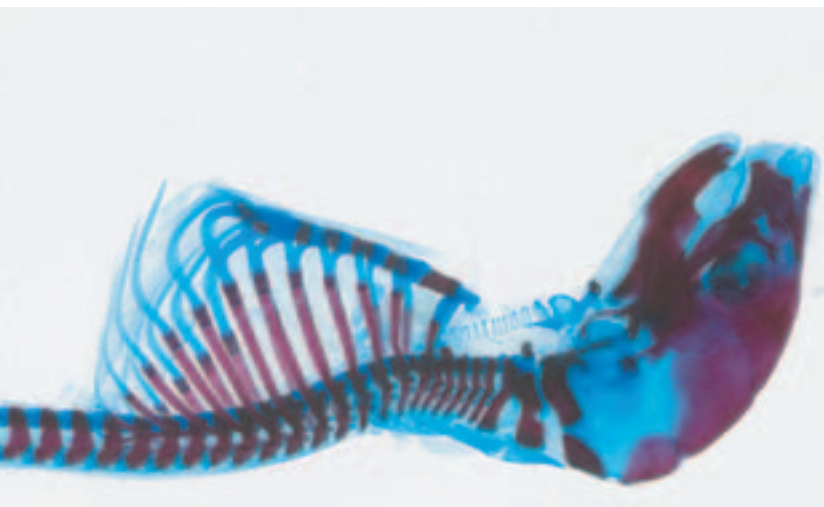

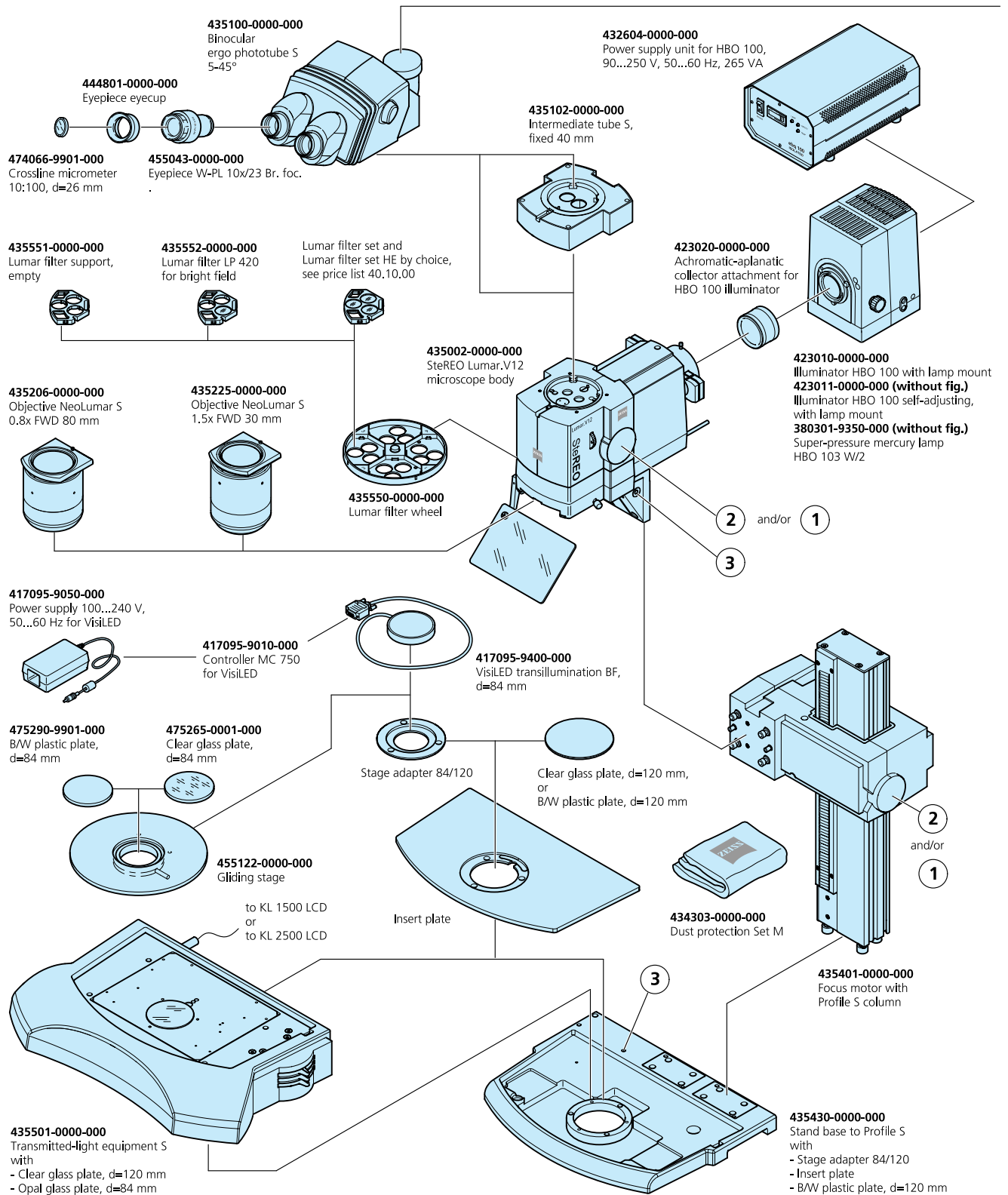



# System overview

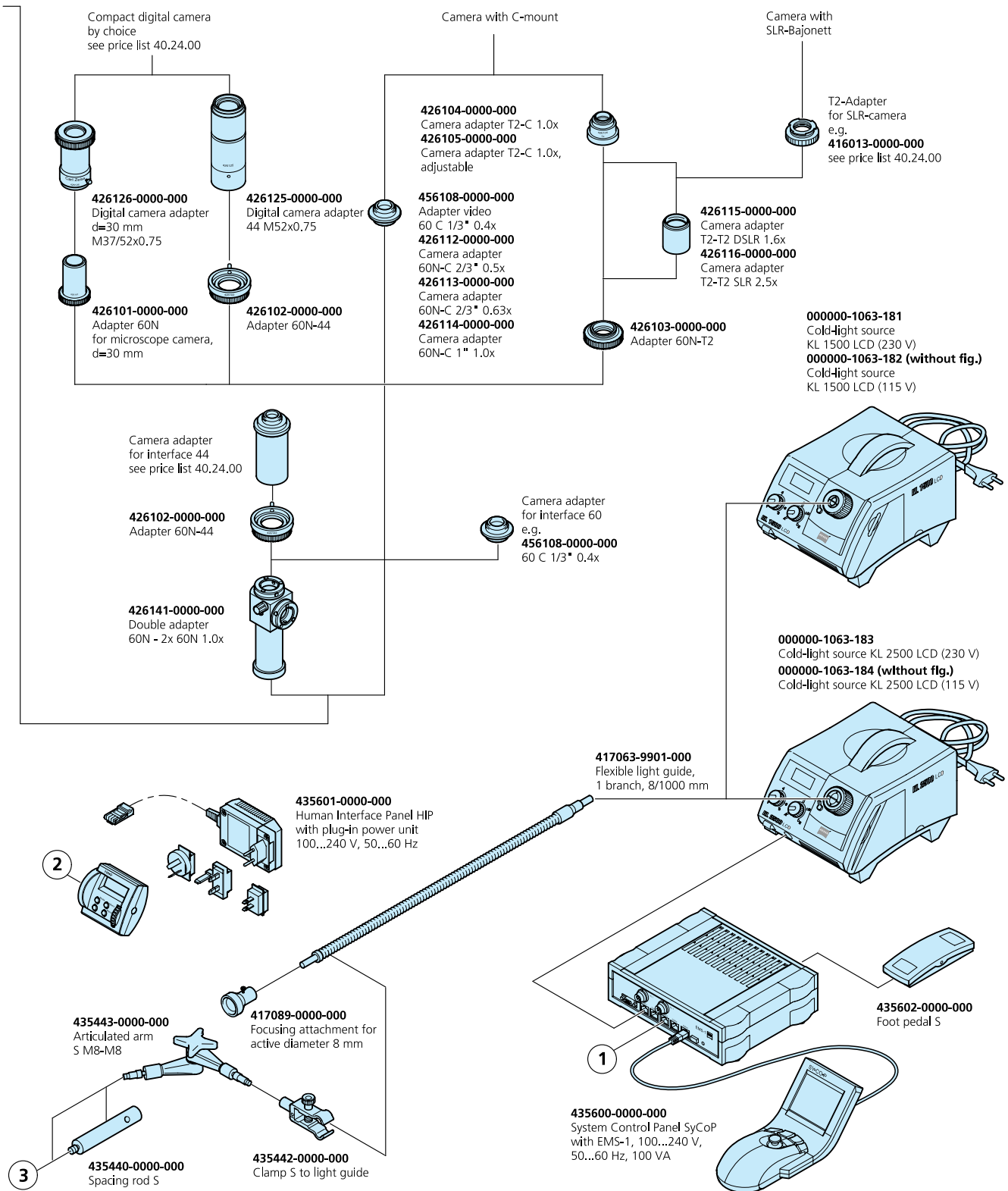

# Technical data

## Objectives

## Eyepieces

description FWD*		WPL 10x/23 Br. foc		PL 16x/16 Br. foc		W 25x/10 foc	
Factor	(mm)	Magnification	Object field (mm)	Magnification	Object field (mm)	Magnification	Objektfeld (mm)
<b>NeoLumar S</b> <b>0,8x</b>	<b>80</b>	<b>6,4x ... 80x</b>	<b>35,9 ... 2,9</b>	<b>10,2x ... 128x</b>	<b>25 ... 2,5</b>	<b>16x ... 200x</b>	<b>15,6 ... 1,3</b>
<b>NeoLumar S</b> <b>1,5x</b>	<b>30</b>	<b>12x ... 150x</b>	<b>19,2 ... 1,5</b>	<b>19,2x ... 240x</b>	<b>13,3 ... 1,1</b>	<b>30x ... 375x</b>	<b>8,3 ... 0,7</b>

\* Free working distance

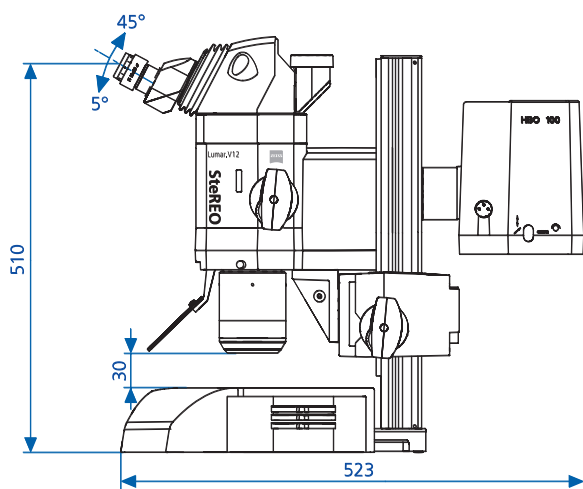

**Weight** ca. 37 kg

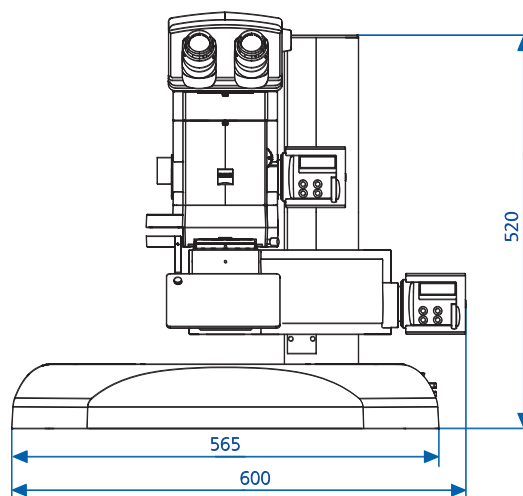

**Carl Zeiss**  
Light Microscopy

P.O.B 4041  
37030 Göttingen  
Germany  
Phone: +49 551 5060 660  
Telefax: +49 551 5060 464  
E-Mail: [micro@zeiss.de](mailto:micro@zeiss.de)

[www.zeiss.de/stereo-lumar](http://www.zeiss.de/stereo-lumar)